



100
YEARS ANNIVERSARY

For a hundred years, INAX has created aesthetic ceramic tiles and bathroom products with one unwavering passion: to enable people to live well.

With an unmatched mastery in understanding the properties of clay and harnessing the power of water, we continue our pursuit of craftsmanship, maximizing the blessings of nature.

Building on our heritage in ceramics, we offer intricate tiles in various forms and hues that add a touch of warmth to the cityscape and products that enable cleanliness and comfort and fit esthetically within the bathroom space.

INAX reimagines the entire bathroom experience, creating a calming environment that embodies Japanese rituals of water - navigating you to a deeper level of relaxation and rejuvenation.

Take a moment to reflect in serenity. Achieve harmony of your body and mind. Embrace your true self and be energized for what lies ahead tomorrow.

LIVE WELL

100 years website





INAX 100 YEARS
ENABLING EVERYONE TO LIVE WELL



INAX DESIGN: REIMAGINING THE BATHROOM EXPERIENCE

The beauty of a shape renders value in enriching the feelings of those who see it. INAX further enhances the value of design, combining it with innovation that reimagine the bathroom experience. As if they were equipment that changes one's feelings, toilets, bathtubs, wash basins, faucets, tiles, and bathroom spaces all bring about a deeper level of relaxation and the vitality to feel positive.

INAX Design continues to visualize new value, to help you be the best you can be.

DESIGNING THE OVERALL BATHROOM SPACE TO FIT AESTHETICALLY IN THE ARCHITECTURE



No single product can help people feel relaxed and energized by itself. At INAX, we cultivate the coordinated elegance of the overall space.

Maximizing the horizontal and vertical lines of the tiles, INAX places products in an organized fashion, carefully designing the space to make the bathroom a sanctuary of comfort. Positioning the thoughtfully designed products developed with a deep understanding of users' desires, INAX Design effectively connects people with the surrounding architecture.

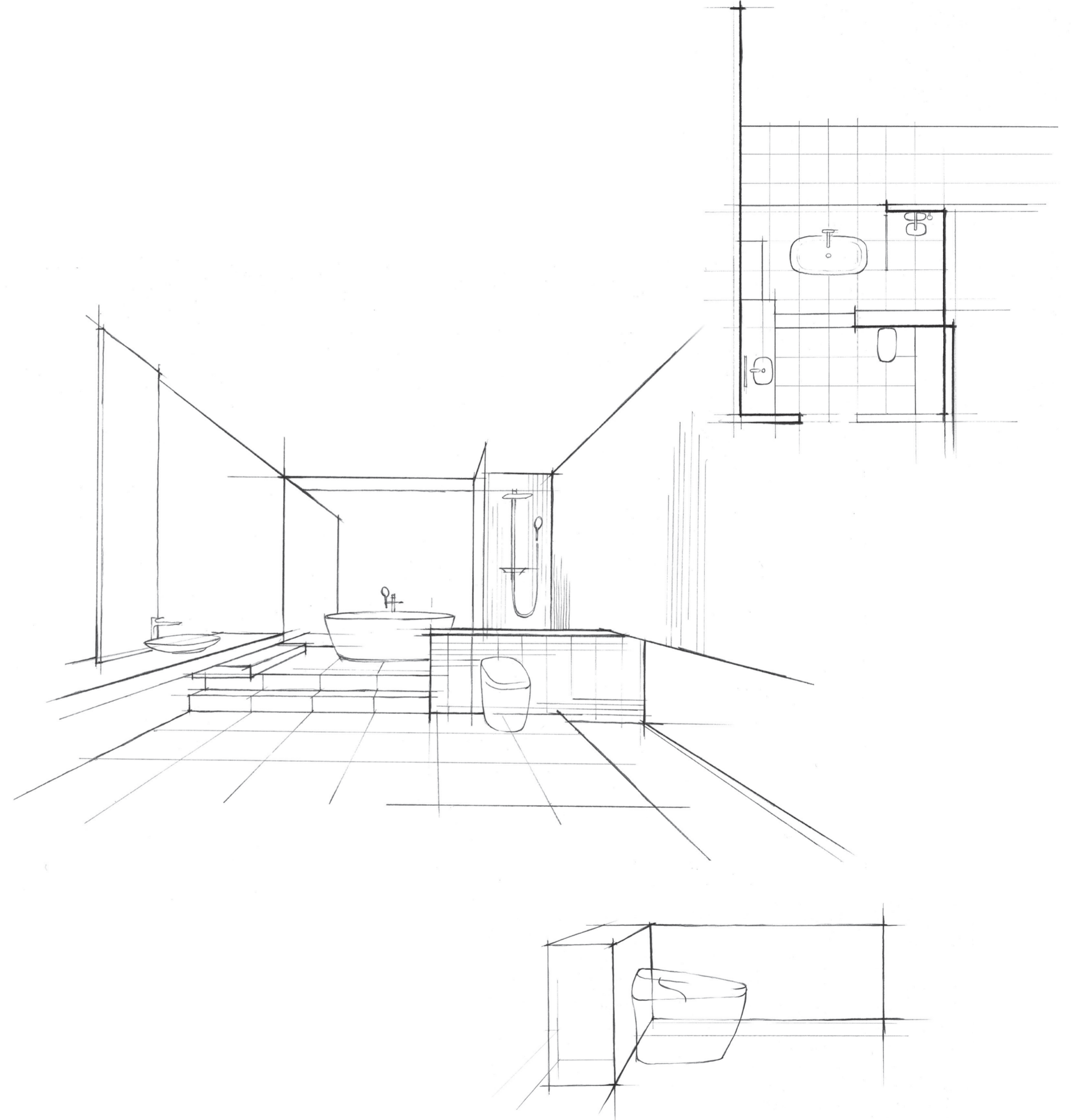

EMBRACING NATURE IN EVERYDAY LIFE



Living in a land of four seasons, with picturesque mountains and abundant water and woodland, the Japanese have long embraced nature as an integral part of their way of life.

Celebrating the seasonal changes and appreciating the blessing of water, being connected with nature in everyday life helps one feel relaxed, refreshed, and whole.

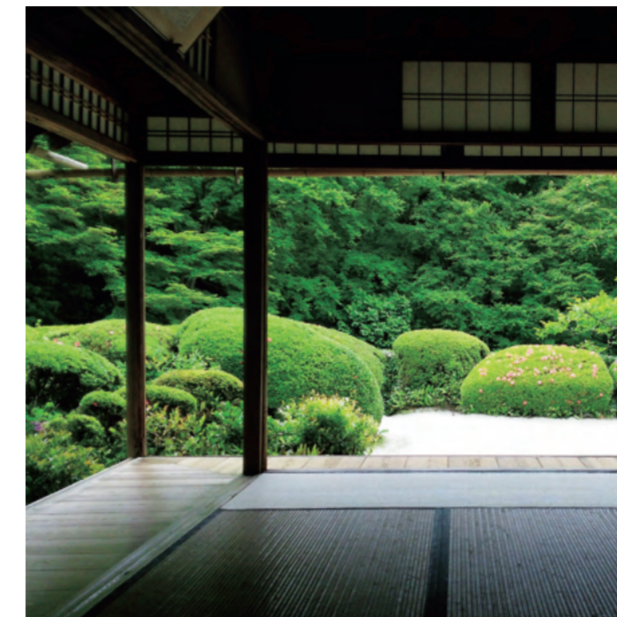

NATURE AND ARCHITECTURE

Japanese architecture has traditionally united the outside with the inside, creating a sense of harmony between nature and architecture. Incorporating the view of the garden or the surrounding landscape into the overall aesthetics creates beautiful spaces where one can feel a deeper connection with nature.



CELEBRATING THE SEASONS

Cherry blossoms in spring. Fresh green leaves in early summer. Harvest moon and colorful foliage in autumn. Snow-covered landscape in winter. Appreciating the four seasons is ingrained in Japanese culture. By cherishing the change of seasons, one can connect with nature's energies and feel renewed and alive.



THE POWER OF WATER

Since ancient times, water has been used in Japan to refresh the mind. When attending a tea ceremony, guests wash their hands and rinse their mouths using the stone basin in the garden before entering the teahouse to clear their minds of worldly thoughts and prepare themselves for the ceremony.

TRANSFORMING THE BATHROOM EXPERIENCE WITH JAPANESE SPATIAL AESTHETICS

How would a design that embraces nature transform the bathroom experience?

A sense of being surrounded by nature in the open air, generated by the view of the outside greenery. The feeling of peace and tranquility, reinforced by the zen garden that connect the inside

and outside. Dividing the bathroom in a uniquely Japanese style inspired by the Furosaki-byobu highlights the beauty of the products and enhances the charm of the overall space. Just like the relaxing outdoor hot springs in Japan, the bathroom that embraces nature is a place to self-reflect, recharge, and rejuvenate.

Furosaki-byobu, low, two-leaf folding screens used at tea ceremonies, serve to divide the space and enhance the appearance of the utensils.



FUROSABI-BYOBU



DESIGN THAT REFLECTS THE TRUE ESSENCE

INAX has a defined set of Brand Design Values, which are shared by all designers to study thoroughly and further develop the INAX Design.

ESSENCE

Reducing things to their fundamental purpose. Celebrating innovation while removing the unnecessary to sharpen their perceived quality. Driving simplicity through honesty, purity and function.

SOPHISTICATION

The celebration of quality and craftsmanship, attention to detail, fit, feel and finish. Every element is intelligently organized with a respect for tradition and etiquette.

THOUGHTFULNESS

Created through a deep understanding of user needs, both articulated and unarticulated. Easy to use, intuitive and considered, resonating the care and dedication with which they were designed and made.



INAX SIGNATURE ELEMENTS

INAX signature elements illustrate the philosophies and values underlying the brand, nurtured over the years in Japan. Being INAX's design DNA, they ensure that all INAX products have a consistent look.



SQUOVAL



A hybrid shape created from a square and an oval, which INAX has aptly named a "Squoval". This unique hybrid geometry celebrates the friendly and human shape of the oval with the structure and architectural relevance of the square. The combination of human and architectural elements (humanitecture) helps to create a form which is both conscious of the architectural space in which it will be placed and demonstrates a sensitivity toward human interaction, connecting people and architecture.

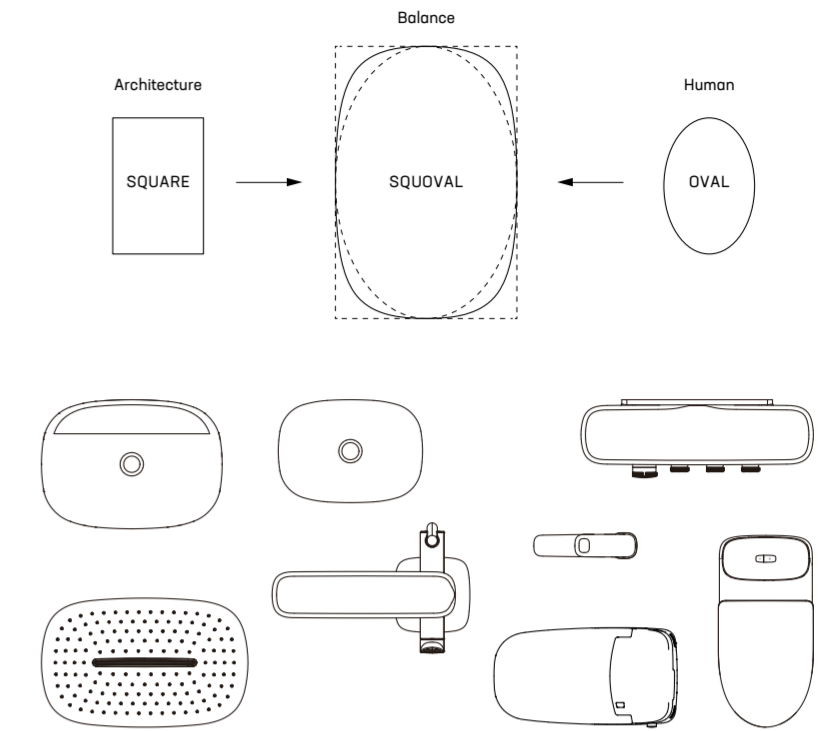

TENSION



Inspired by the surface tension of water, this element gently reflects light and invites interaction. This detail adds a controlled yet dynamic element to an otherwise flat surface. Like the edge of a samurai's sword, it is precise, elegant and beautiful. The form has an embedded function and acts as a guard to water; its symmetrical incline gently repels liquid.

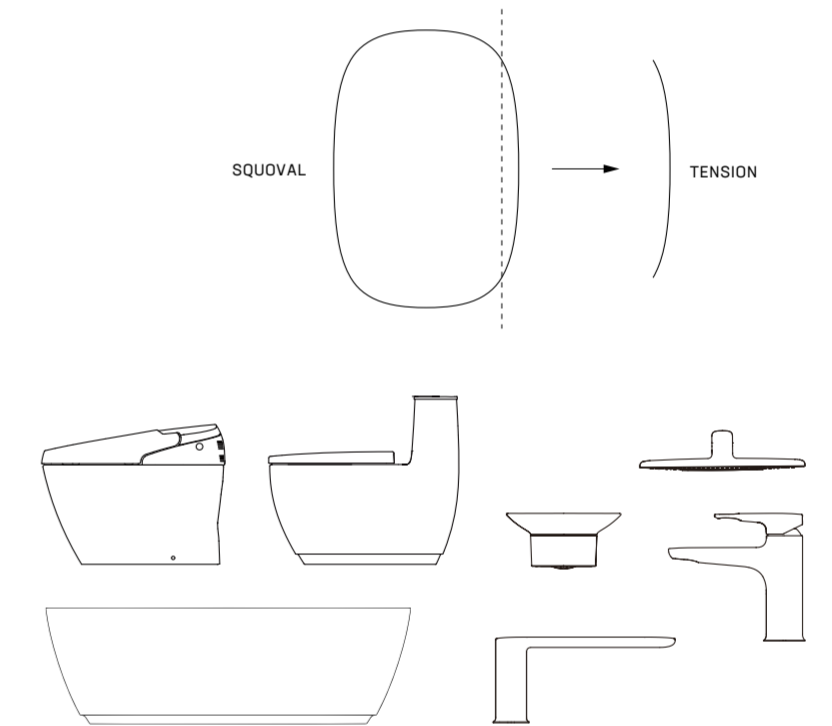

VOLCANO



Flowing from one surface to the next, the volcano is a controlled organic transition, inviting interaction and intuitively guiding the user to a point of importance. The volcano is easy to clean and maintain and is robust yet elegant.

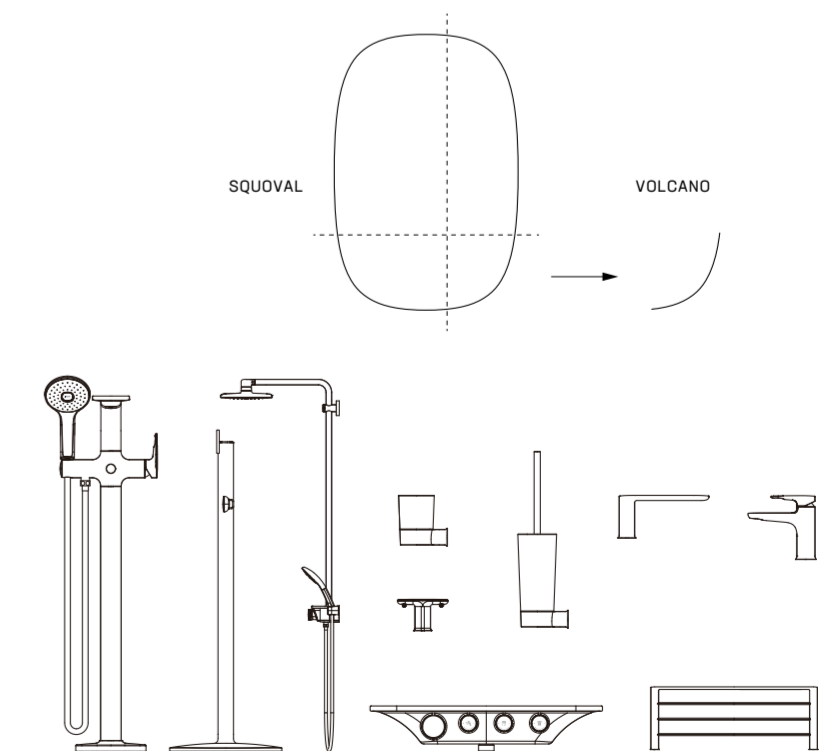

INAX INNOVATION: TRANSFORMING BATHROOMS AROUND THE WORLD

INAX is continuously developing new technologies, transforming bathrooms from mere functional necessities for personal hygiene to beautiful and comfortable spaces that refresh and energize people's mental and physical state. Delivering new value from the users' perspective, innovation by INAX continue to not only lead the industry in Japan but also influence the global market.

SHOWER TOILETS

INAX's shower toilets are forever evolving in both function and design to deliver further comfort and satisfaction.

INAX's passion is to manufacture creative products that help people live well. Starting with the launch of the first made-in-Japan shower toilet in 1967, INAX has consistently continued its quest for innovation, always in pursuit of what customers might need or want, bringing more comfort and cleanliness to people's lives.



DUAL NOZZLE

INAX's shower toilets feature a rear-wash nozzle and another dedicated for the female bidet function. Unique to INAX, the dual nozzle structure caters to women's concerns about cleaning their intimate area with the rear-wash nozzle.

TRIPLE VORTEX FLUSH

Triple vortex flush technology harnesses the force of three jet streams to powerfully and efficiently flush the entire surface of the bowl, ensuring an unprecedented level of hygiene.

AQUA CERAMIC

Through its super-hydrophilic performance and adopting a structure that prevents the buildup of limescale, AQUA CERAMIC allows the toilet bowl to retain its shine for 100 years with simple daily cleaning.

FOAM CUSHION

Automatically creating a 5-15mm thick micro foam with a bubble diameter of 400µm (micrometers) or less in the toilet bowl, this innovation developed in 2016 helps reduce urine splash.

AIR SHIELD DEODORIZER

This innovative technology achieves a powerful deodorizing effect by circulating a curtain of air within the toilet bowl which prevents odor from escaping, keeping the toilet area fresh and pleasant.

AUTOSEAT

AutoSeat, launched in 1992, automatically lifts the lid and seat when the user approaches the toilet and lowers upon exit, providing a hygienic alternative to raising the toilet seat by hand.

MATTE FINISHED CERAMIC

INAX's unique colored ceramic with smooth matte finishes is the fruit of our technical expertise, built on our heritage of developing tiles in partnership with architects and designers.



INAX has a hundred years of experience in manufacturing custom made ceramic tiles that measured up to the needs and ideals of many architects and designers, starting with Frank Lloyd Wright. Our ceramic technology is built on a wealth of techniques, knowledge,

and experiences, accumulated over decades of research, development, and manufacturing in pursuit of optimal colors and textures. It is this ceramic technology that makes possible the luxurious feel and expression of the matte black SATIS.



CERAFINE

Refined, superior ceramic wash basins, bringing together INAX's innovative technology and its passion for contemporary design.

Delicately designed with super-thin edges, CERAFINE's beautiful wash basins have a refined look and feel. The modern design adopts gentle curves that resemble a Torii gate of a shrine or a blade of a Japanese sword. This simple curved line called "Sori" not only represents strength and functionality but also embodies Japanese spirit and sensibilities such as serenity and quality.

For its plane proportion, CERAFINE adopts the silver ratio. Traditionally used in Japanese architecture, the silver ratio enhances the beauty of the blank space, contributing to CERAFINE's exquisite Japanese Zen design. Through technological innovation, CERAFINE has achieved the impossible – delicate ultra-thin vessel while ensuring durable quality.

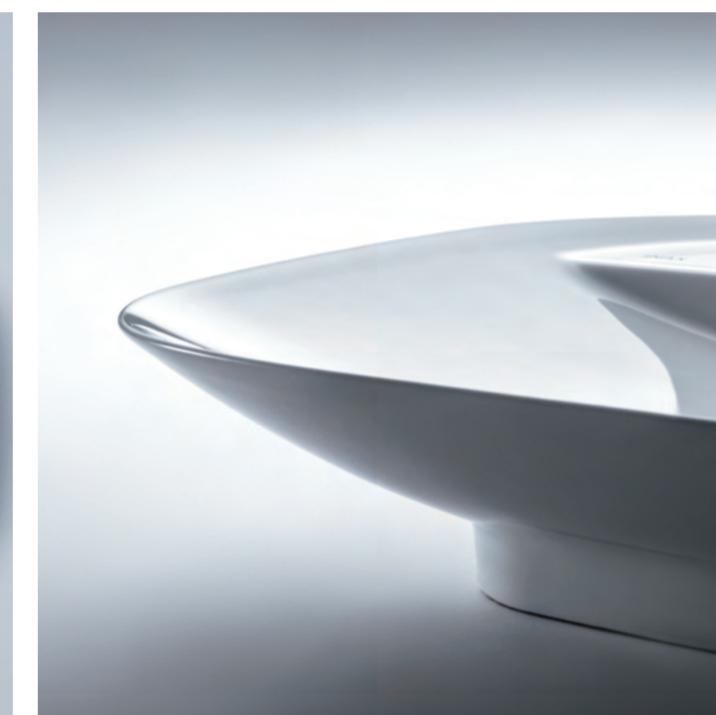

CLEANLINESS

Incorporating the AQUA CERAMIC technology, CERAFINE prevents attachment of dirt on the surface and the buildup of hard water stains, making it easy to retain its shine with simple daily cleaning.

PRECISION

Made with innovative clay that maintains its strength and does not deform during firing, the large but delicate CERAFINE vessel is a result of over three years of research and development and 800 prototypes.

INTELLIGENT CONTROL SHOWER SYSTEM



Ergonomic design and sophisticated engineering perfecting a comfortable and refreshing showering experience, just by a push and turn of a button.

Integrating the faucet with a shelf, Intelligent Control enhances the space utilization within the bathroom while ensuring the minimum space to place the necessary items. The details are carefully designed to fit in total harmony within the overall bathroom space and secure ease of cleaning, such as a slight edge on the shelf to prevent items from falling off, a slit at the back to prevent water from pooling, an easy-to-grip shower handle, and a showerhead size calculated to provide a comfortable shower. Intelligent Control allows you to enjoy your customized shower experience every time by simply pre-setting your preferred temperature and volume of water.



The shower starts and stops by pushing the button.



Users can adjust the water by turning the dial.

JAPANESE TILES

Artistic Japanese tiles inspired by traditional motifs, designed to create stylish spaces harnessing the Japanese spirit of hospitality.

With its roots in the production of tiles and terracotta for the Imperial Hotel designed by Frank Lloyd Wright, INAX offers an extensive collection of high-quality design tiles, inspired by Japanese culture. The Japanese have long lived in harmony with nature, the appreciation of which has continued to be essential motifs for art and culture in Japan. INAX brand tiles build on the unique Japanese sensitivity toward the

beauty of nature, such as changing seasonal hues, rural scenery, the flow of waves, and more. Incorporating traditional motifs and techniques, they offer a dynamic play of light and shadow, created through intricately designed shapes or carefully calculated differences in thickness. Their sophisticated, stylish ambiance is sure to enable INAX customers to create beautiful, modern spaces.





FORMAT-MIX

FORMAT-MIX combines tiles of three different sizes, with matte and reflective finishes. The geometric play of exquisitely crafted tiles offers a rhythmical, stylish effect.

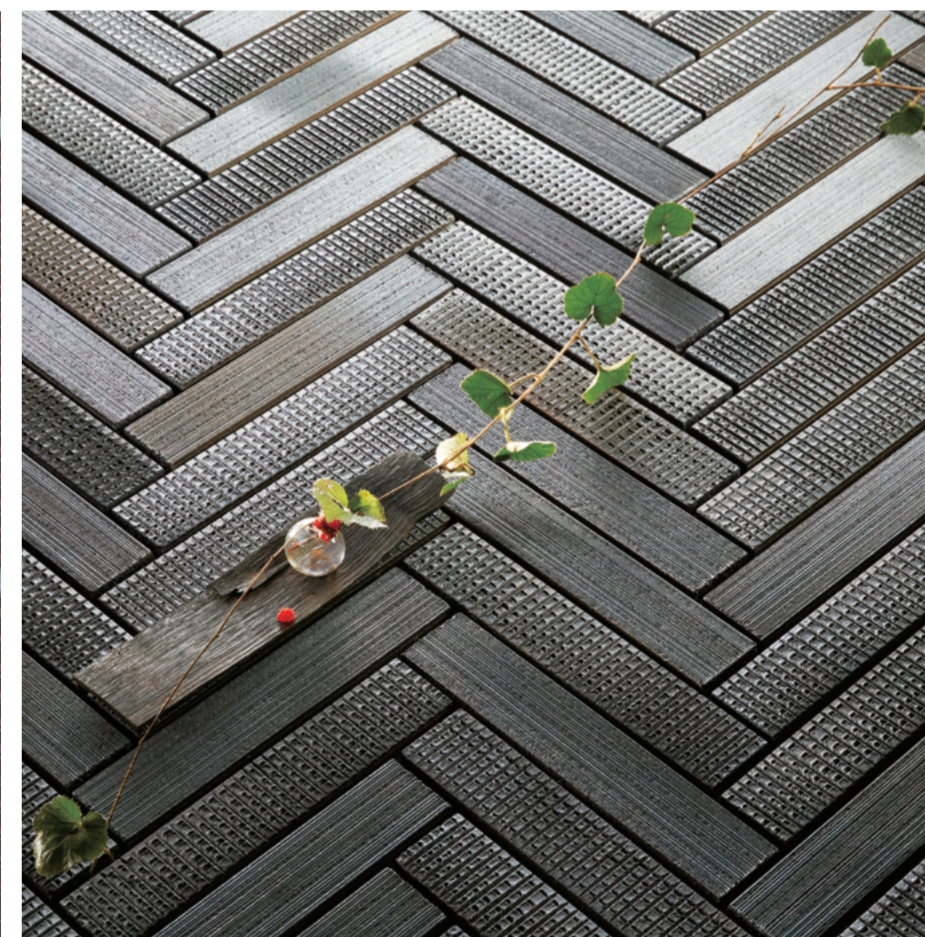
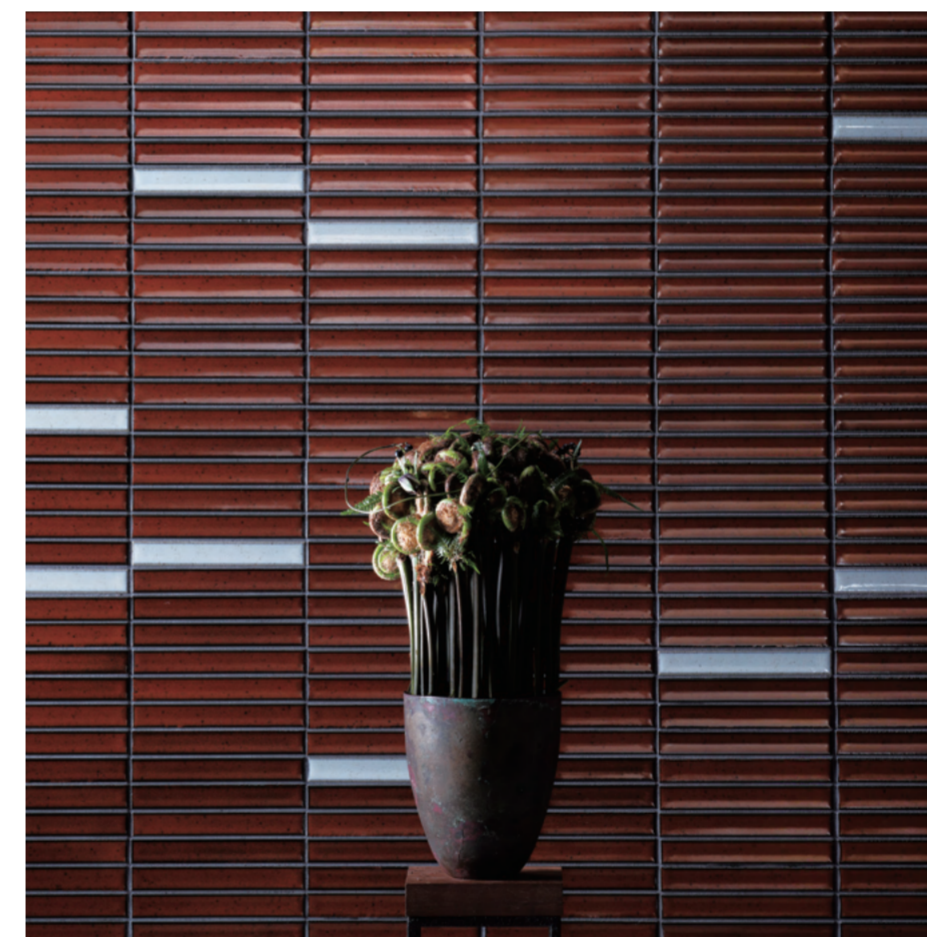

IZUMO

IZUMO is a large, sophisticated tile with a distinct double concave form. Its uneven surface and exquisite glaze reflect the light gently, creating beautiful walls for interior and exterior use.

YUKI BORDER

YUKI BORDER features a gentle curve and a distinct earthenware glaze. It is recommended for interior use to decorate spaces such as entrances for homes, or restrooms for stores.

YOHEN BORDER

YOHEN BORDER is a small, delicate mosaic tile with a gently variegated Japanese-style glaze finish. The random colors in each piece combine to help create a modern ambiance.

HOMURA

HOMURA tiles feature distinctly ceramic color change and two different surface finishes. The earthy texture of the tiles creates an impressive Japanese atmosphere.

Tiles designed by preserving Japanese sensibility, refinement, and techniques, taking inspiration from traditional Japanese culture and seasonal colors.



立涌

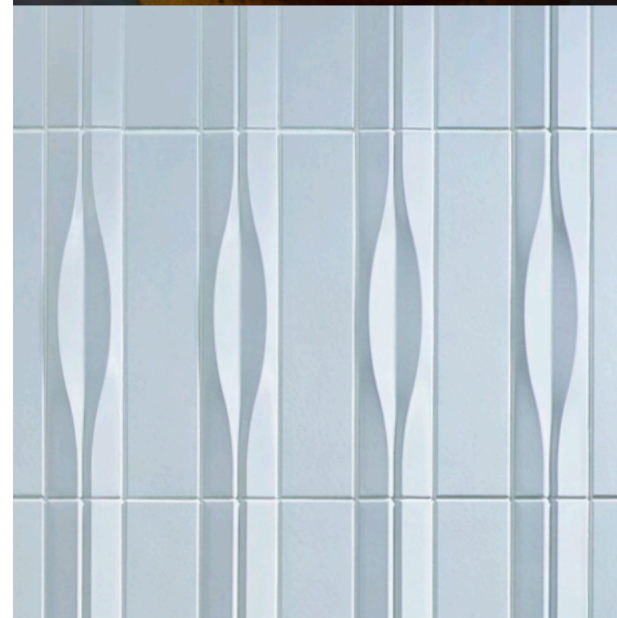

YUMON × TATEWAKU

The YUMON is a pair of two curved lines, one bulging and the other indented, that boldly and rhythmically compose the space. It is inspired by the traditional Japanese pattern "Tatewaku," which has been used since the Heian period (794-1192) to simply express the appearance of rising water vapor. Since ancient times, the pattern of "Tatewaku" has also been referred to as the shimmering flames of a rising sun or rising clouds and is considered an auspicious and auspicious pattern.



羊羹



YOHEN BORDER × YOHKAN

The Japanese have traditionally expressed the wonders of nature by portraying the changes of the four seasons in sweets such as Yohkan, a classic thick jellied confection made from beans. Like the gradation of colors in the scenery, YOHEN BORDER offers a spectrum of subtle color differences across every single piece.



朧



CRESCENT BORDER × IRAKA

Iraka, roofs of traditional Japanese houses, are made with ceramic tiles that collectively create a picturesque image of waves formed in the sky. Similarly, the spatial formation using CRESCENT BORDER tiles, individually shaped in the form of a crescent moon, presents a laced arrangement that looks like ocean waves shining with moonlight.



籠



RHYTHMIC II CROCHET × KAGO

Woven geometry can be found all around the world. Baskets and colanders woven from bamboo have been implements used in Japan for centuries. A piece-by-piece combination of beauty emerges from simple, regular patterning, and results in bold shading that transcends East and West. The appearance is decidedly impressive.



鹿の子

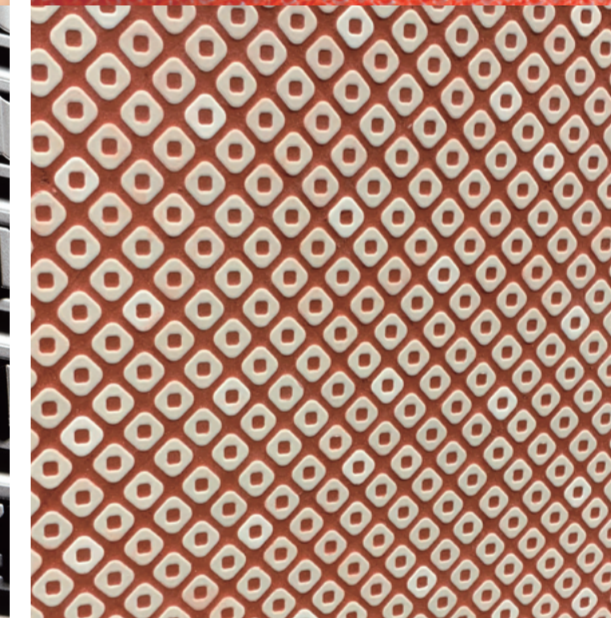

KANOKO × KANOKOSHIBORI

One form of shibori, the Japanese manual resist-dyeing technique, is Kanokoshibori, which involves binding minuscule portions of fabric with a thread before dyeing. When untied, the bound parts remain white, resembling the pattern of a fawn's back, from which the name was derived. KANOKO features a gentle Japanese design using this artisan technique as a motif.



江戸小紋



YUKAGE × EDO-KOMON

The graceful and delicate expression of the YUKAGE. It is a projection of the world of "Edo-komon," a dyed fabric that has been handed down since the Edo period (1603-1868). These patterns are refined with the aesthetic sense of "iki" (style) cultivated in the Edo period. The designs used in YUKAGE are all considered to be auspicious. The pattern in the photo is one of them, "Hemp leaf". The design of neatly lined up hexagons is meant to ward off evil.

ECOCARAT

Innovative technology underlying beauty and design. ECOCARAT ceramic interior tiles freshen the air and control humidity, enhancing comfort in the home.

ECOCARAT tiles are attractive, functional interior ceramic materials that offer exceptional odor reduction and humidity and condensation control. Produced from a natural clay-like mineral, ECOCARAT breathes through its countless micropores, refreshing the air by eliminating odors from toilets, food, cigarettes, and pets, and reducing harmful substances in the atmosphere, such as formaldehyde and toluene. It also maintains the

humidity level to a comfortable level, preventing the spread of mites and molds and helping to keep the skin soft and moist. A range of ECOCARAT tiles is now available in various designs to transform both homes and public spaces both functionally and aesthetically.

ECOCARAT's air-freshening effects differ depending on environmental conditions such as the room in which it is used, weather, ventilation, etc.

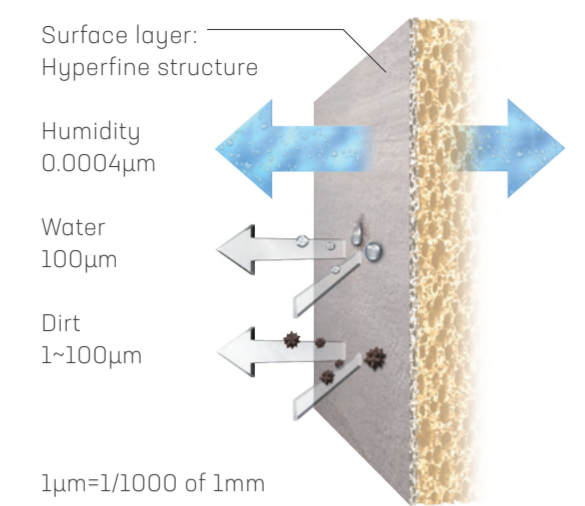

Highly precise decoration, designed to surpass the original beauty. With the designers' thorough knowledge of the materials used as motifs and enhanced decorating techniques, INAX can now express the real texture of stones and wood through colors and patterns. As INAX can now continuously produce complexly patterned tiles, the resulting interior will have a more natural atmosphere.

THE STORY OF INAX

When asked the reason why INAX can help people live well, INAX answers:
Japan is a country that respects the beauty of nature and people, and INAX is a brand nurtured by Japan's unique tradition and culture, inheriting the techniques and spirit of craftsmanship, relentless in the pursuit of quality.
Just as unique as Japan is in the world, INAX aims to become the brand of choice for people around the world.

JAPANESE SPIRITUALITY AND WATER

Japan is a country blessed with an abundance of water. The Japanese have not only used water to live, but have traditionally placed it in places to reset one's soul, believing that water has the power to wash away impurities.

Shrines welcome visitors with a fountain to purify their hands, as they switch from the secular world to the sacred. Through expressing the flow of water with raked gravel, Zen rock gardens allow the beholders to regain peace in their minds.

With numerous natural hot springs available throughout the country, the Japanese also have a deeply rooted custom of taking a bath to wash away the fatigue and recharge for what lies ahead tomorrow.



A SPACE FOR SELF-REFLECTION

The undecorated beauty of the room is what touches our hearts. With a sense of delight upon the moment of entry, in an instant, the mind switches as if one entered a different world.

In a minimalist space rid of all excesses, one may sometimes feel the tranquility and at other times a comfortable tension, depending on the state of mind at the time, even if the scenery is the same.

It is in such a space embracing Japanese serenity that one can enjoy a moment of self-reflection.



INSPIRATION FROM JAPANESE BEAUTY AND TECHNIQUES

Japanese forms exert their allure through various elements. The breathtakingly beautiful lines. The unique colors and luster. The meticulously skilled precision which one cannot believe is handmade.

All these components change and dignify the surrounding atmosphere, and give comfort to everyone who sees them. Highly regarded outside Japan, ageless Japanese beauty and techniques have inspired contemporary designers, marking a footprint in the products they design.



Torii gate (doorway to the sacred area) standing in the sea. The slight but splendid curve is a traditional Japanese form since ancient times.



The techniques of the artisan bring about Japanese beauty. Understanding the characteristics of natural materials, they assemble the parts with precision beyond what a machine can do, creating the forms, and emphasizing the beauty and strength.

INAX AND FRANK LLOYD WRIGHT

The spirit and techniques of manufacturing that measured up to the ideals of the world's greatest architect became the starting point for INAX.

In the early 1900s, when the number of foreign visitors to Japan began to increase, the Imperial Hotel commissioned Frank Lloyd Wright, one of the greatest American architects of the 20th century, to design its new building. As the tiles and terracotta for the walls were made with clay from the Chita Peninsula in Aichi Prefecture and required molding of original designs and special firing techniques, a dedicated factory was established in Tokoname.

Hatsunojo Ina and his son Chozaburo were invited to become technical advisors for this project. Upon the completion of the hotel, they took on the workers and the equipment of this factory, creating Ina Seito, which later became INAX.



The scratch face tiles which the craftsmen produced through trial and error under the guidance of Hatsunojo and Chozaburo Ina created an atmosphere worthy of welcoming VIPs from all over the world.



Imperial Hotel reconstructed in Museum Meiji-mura

QUALITY GENERATED BY SOIL, WATER, AND FIRE

Throughout its history, INAX has continued to deliver the quality expected of a Japanese brand and unique to INAX.



Tokoname, the birthplace of INAX, is one of the main pottery towns in Japan. With a thousand years of history, it has continued ceramic production since the medieval times. Soil can be formed by mixing with water, and through firing, becomes a piece of ceramic.

At INAX's sanitaryware factory in Tokoname, we run an automated production process programmed with the inherited skills of the craftsman to enhance our precision and production capacity.

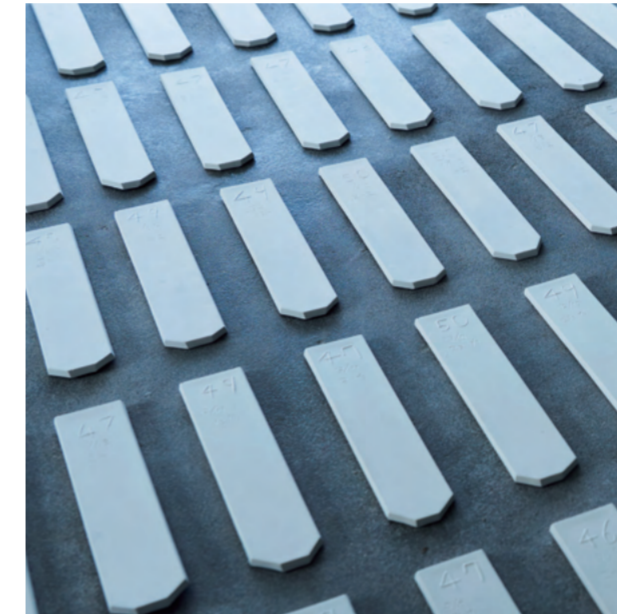

Prototyping plates with different pigments and mixing ratios. INAX continues the evolution of sanitaryware by developing "new clay."

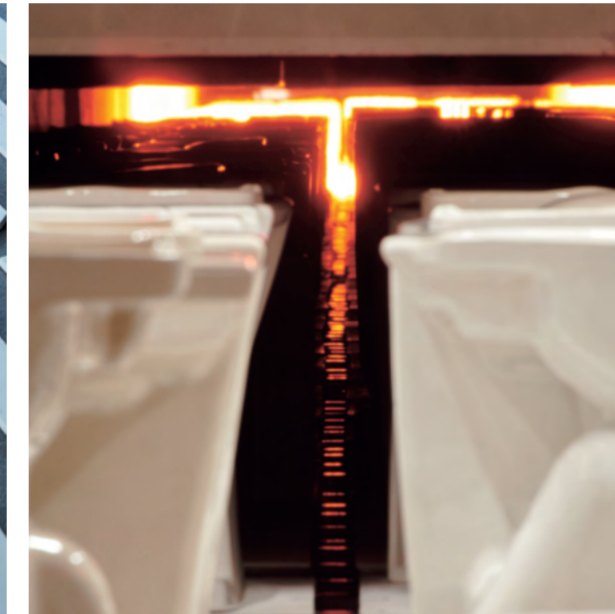

Firing a piece of sanitaryware. Each piece is uniformly fired, through precise computer control.



Assembling a shower toilet. In order to maintain accuracy and speed, INAX uses robotics technology in addition to the eyes and hands of skilled technicians.

The building and a large kiln within, built in the early 1920s, are preserved at the INAX MUSEUMS in Tokoname. They are designated as a Registered Tangible Cultural Property and Heritage of Industrial Modernization.

PASSING ON THE SPIRIT OF INNOVATION

The history of INAX is a legacy of creating the industry's pioneering functionalities and offering new value to people's lives.



1967

SANITARINA 61
FIRST MADE-IN-JAPAN SHOWER TOILET

Sanitarina 61, launched in 1967, became the starting point for changing the shower toilets from what was predominantly for medical use to a universal facility used by everyone at home.

While Japan is a country that values tradition, it is also a nation which creates innovative technologies. INAX is a leading Japanese manufacturer of sanitaryware. Innovating home shower toilets from the model used in the West as a medical device, INAX became the driving force for changing people's everyday life in the bathroom.

To this day, we have continued to succeed in numerous innovations not only in shower toilets, but also bathtubs, faucets, and tiles. Everyone wants to live a healthy, vibrant life. INAX will continue to pass on the spirit of innovation to help everyone live well.



> TODAY

SATIS
SHOWER TOILET

At the forefront of shower toilets, which started with Sanitarina 61, is SATIS. SATIS changed the overall toilet space by making it beautiful, comfortable, and odor free.

INAX HERITAGE

1910 >



1918
Appointment of Hatsunojo and Chozaburo Ina as technical advisors to produce the tiles for the Imperial Hotel, designed by Frank Lloyd Wright.

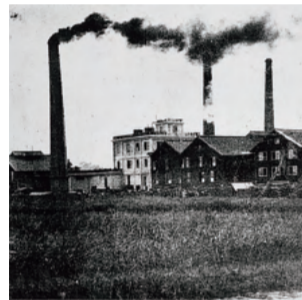

1924
Establishment of Ina Seito Co., Ltd. (Managing Director: Chozaburo Ina) Production of ceramic tiles, pottery pipes and terracotta.



1945
Start of sanitaryware production.



1967
Launch of Japan's first shower toilet with warm water shower spray and dryer function –Sanitarina 61.



1976
Launch of INAX's first shower toilet seat Sanitarina F1.

1980 >



1985
Change of company name to INAX Corporation.



1990
Launch of world's first self-powered automatic faucet Automage.



1994
Launch of toilet with KILAMIC –antimicrobial technology which is highly resistant to scratches and stains.



1998
Launch of ECOCARAT functional interior ceramics that control humidity and odor. Winner of Good Design Long Life Design Award.



1999
Launch of toilet with PROGUARD technology for maximum protection against hard water stains and spots.

2000 >



2001
Launch of world's most compact tankless shower toilet SATIS. Winner of Good Design Gold Award.

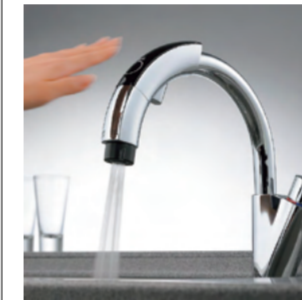

2005
Launch of touchless faucet that supplies water by sensor technology.



2006
Development of intelligent control shower system for prefabricated bath.



2007
Japan's antibacterial measurement standard certified to ISO standard.

2010 >



2016
Launch of new SATIS series. Winner of Red Dot Design Award. (SATIS G)



2016
AQUA CERAMIC –the most advanced hygiene technology. Winner of Good Design Gold Award.



2017
Marked the 50th anniversary of the first made-in-Japan shower toilet launched in 1967.

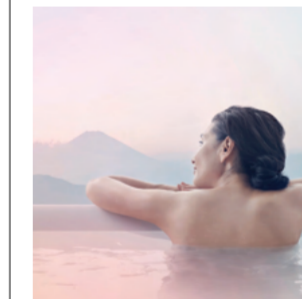

2019
Launch of the new INAX brand identity "Rituals of Water" at Milan Design Week.

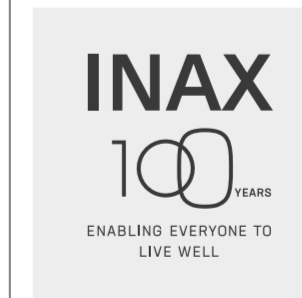

2024
Celebrated 100 years of INAX.

PRODUCT CATEGORIES



Shower Toilets



Toilets



Vanities & Wash Basins



Bathtubs



Showers



Faucets



Kitchen Faucets



Tiles



Public & Commercial

Version 5.0
Published on March 25, 2024
LIXIL Corporation

Printed in Japan
©2020 LIXIL Corporation

All rights reserved. No part of this publication may be reproduced, stored in a retrieval system or transmitted, in any form or by any means, electronic, mechanical, photocopying, recording or otherwise, without permission in writing from the publisher.



INAX.COM

Version 5.0 | 2024.03.25



100 years website